

Battery Supply – 2S LiPo

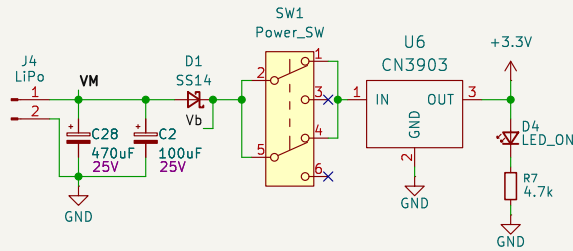

Programming

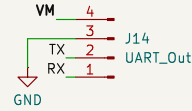

Mounting Holes

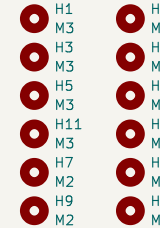

MCU

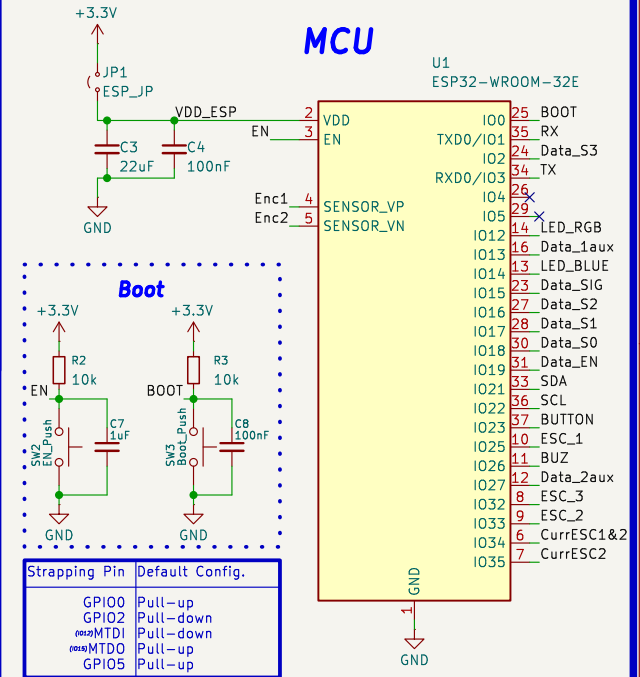

Interfaces

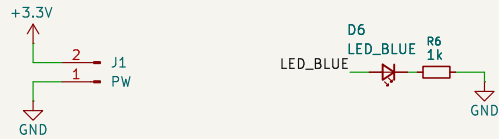

Passive Buzzer

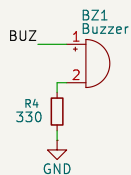

Button

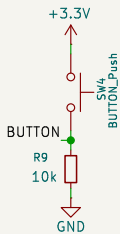

RGB LED

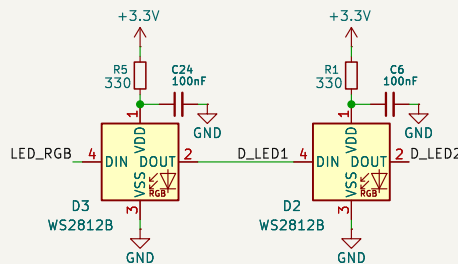

I2C Connections

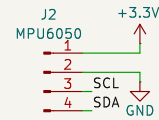

Sensors Input

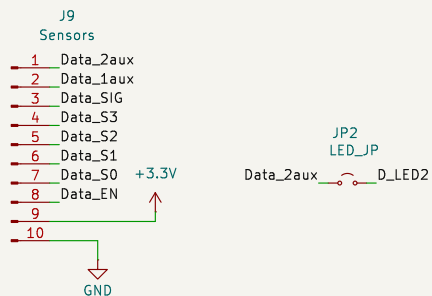

ESCs Connections

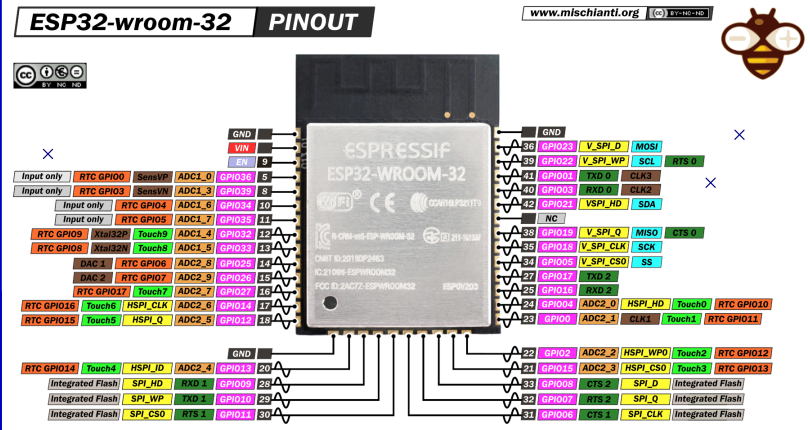
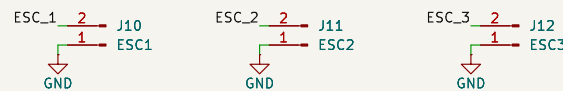

JRegi
 Sheet: /
 File: main_Magic-simple.kicad_sch
Title: MagicAlonso main control PCB
 Size: A4 Date: 2025-06-01
 KiCad E.D.A. 9.0.0 Rev: 1/1