

Sheet: /  
 File: load\_automatisation.kicad\_sch

**Title:**

Size: A4  
 KiCad E.D.A. 9.0.0

Date:

Rev:  
 Id: 1/7

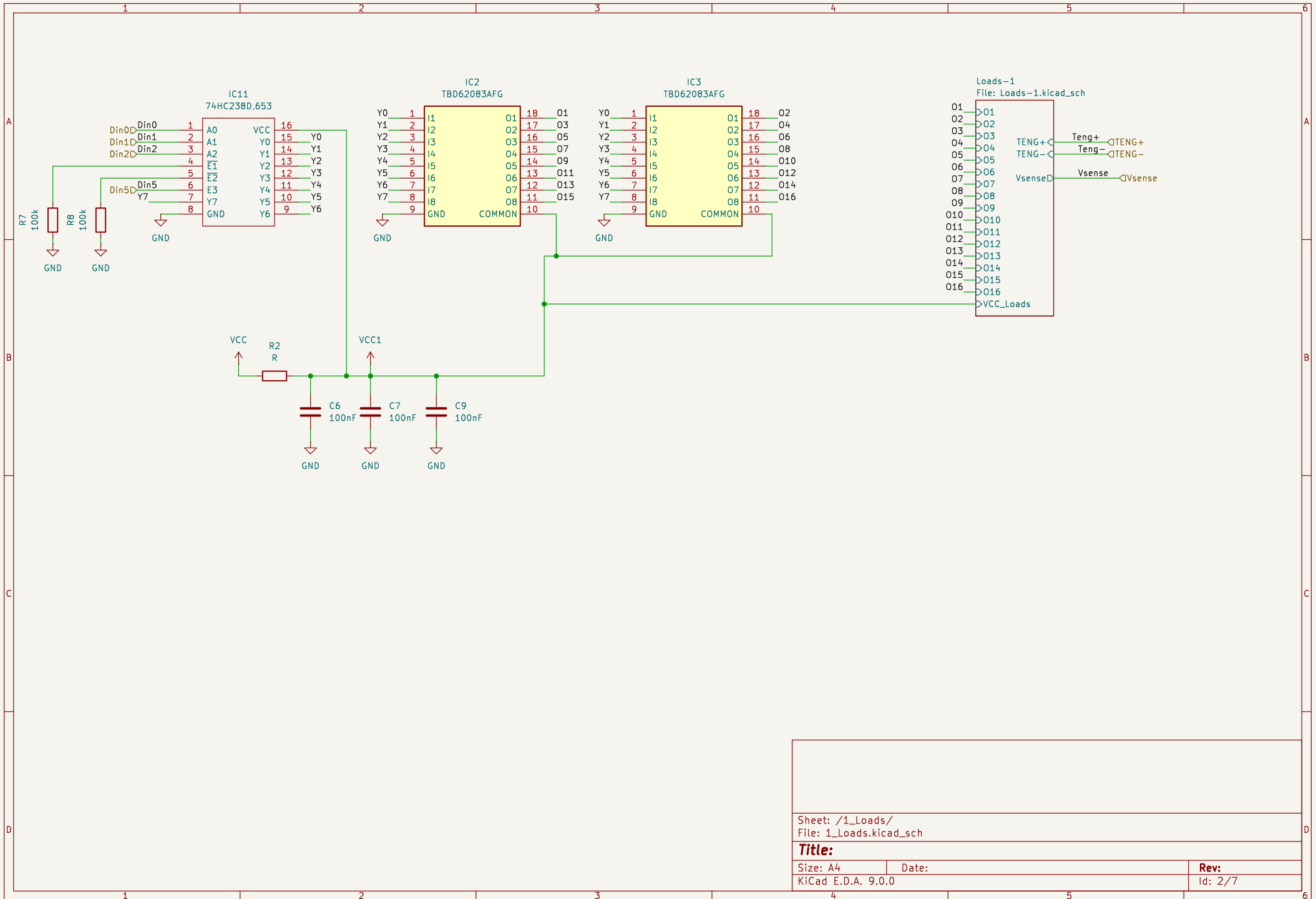

Sheet: /1\_Loads/  
 File: 1\_Loads.kicad\_sch

**Title:**

Size: A4  
 KiCad E.D.A. 9.0.0

Date:

Rev:  
 Id: 2/7

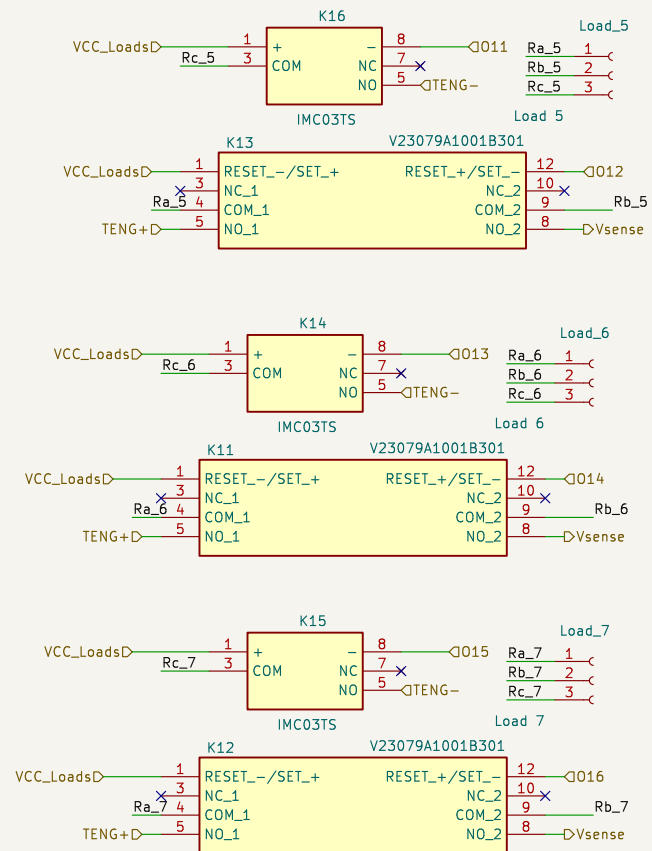
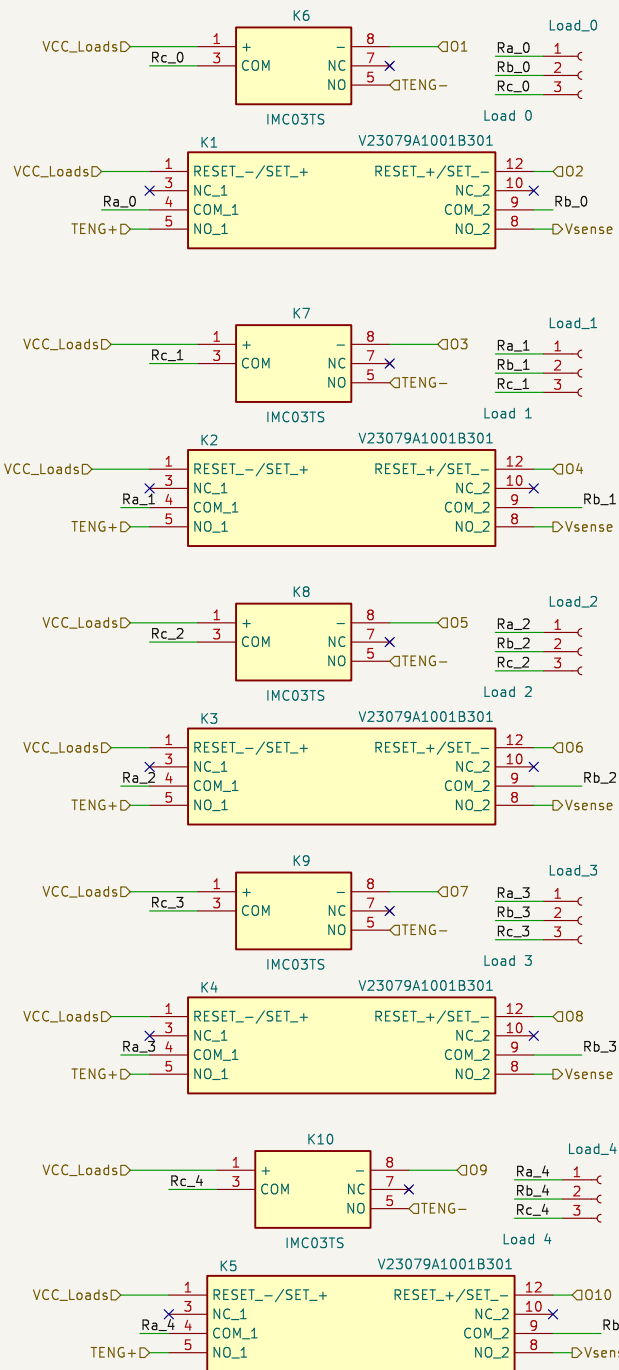

Sheet: /1_Loads/Loads-1/	
File: Loads-1.kicad_sch	
<b>Title:</b>	
Size: A4	Date:
KiCad E.D.A. 9.0.0	Rev: Id: 3/7

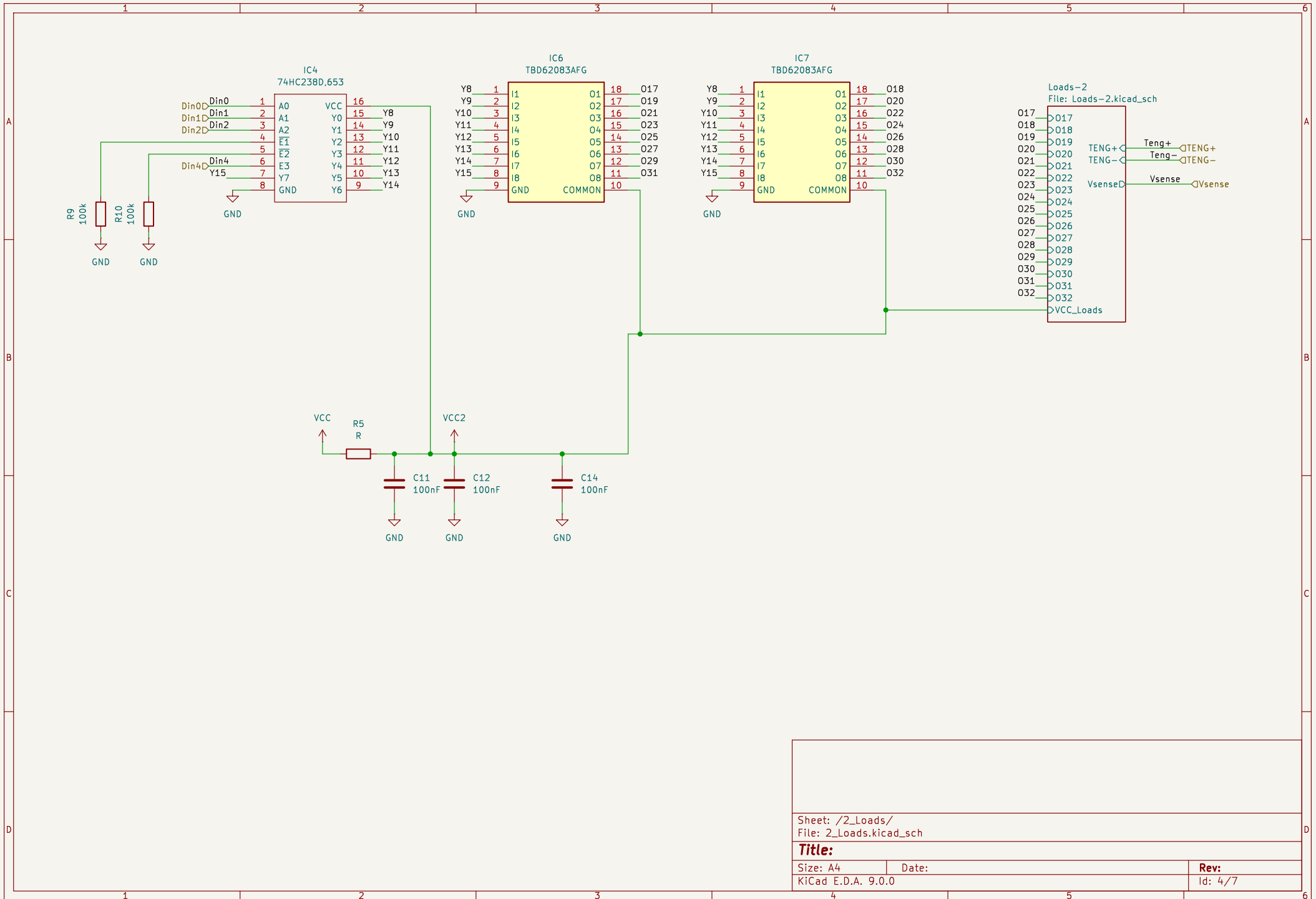

Sheet: /2\_Loads/  
 File: 2\_Loads.kicad\_sch

**Title:**

Size: A4  
 KiCad E.D.A. 9.0.0

Date:

Rev:  
 Id: 4/7

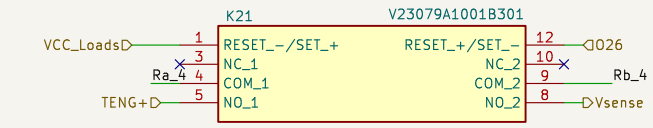
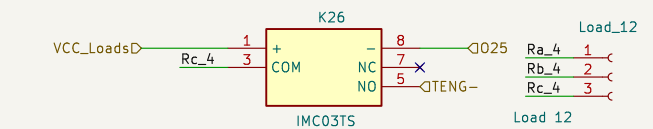
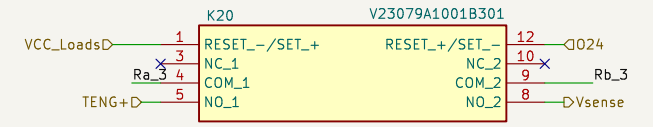
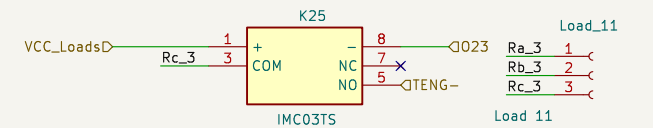
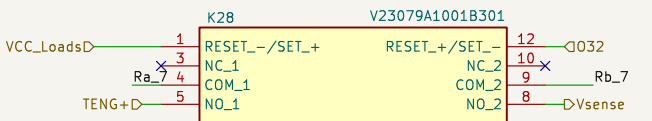
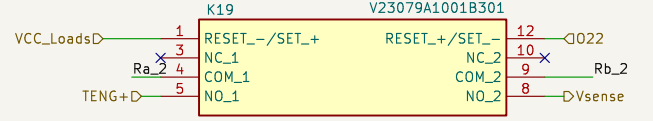
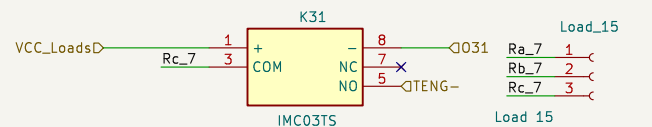
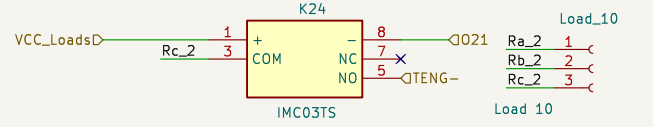
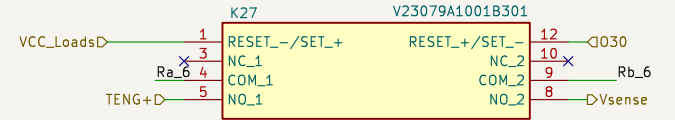
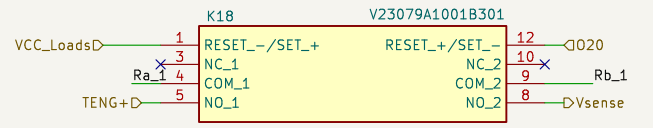
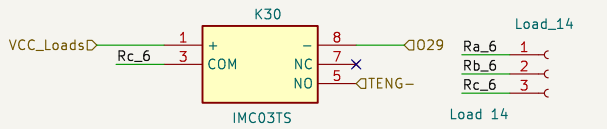
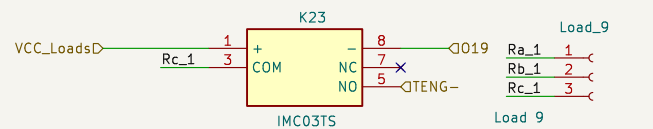
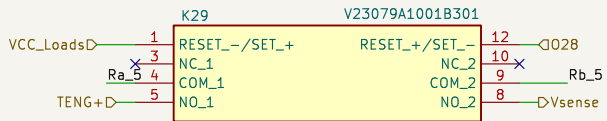
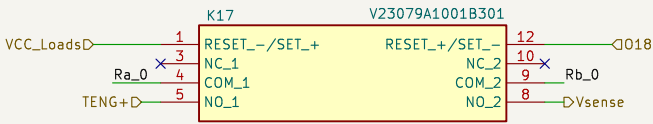
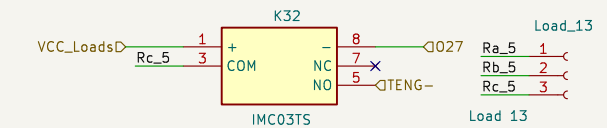
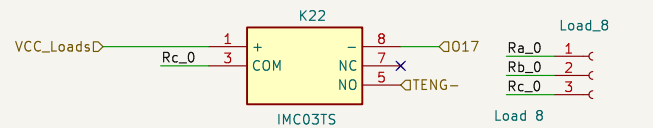

Sheet: /2_Loads/Loads-2/	
File: Loads-2.kicad_sch	
<b>Title:</b>	
Size: A4	Date:
KiCad E.D.A. 9.0.0	Rev: Id: 5/7

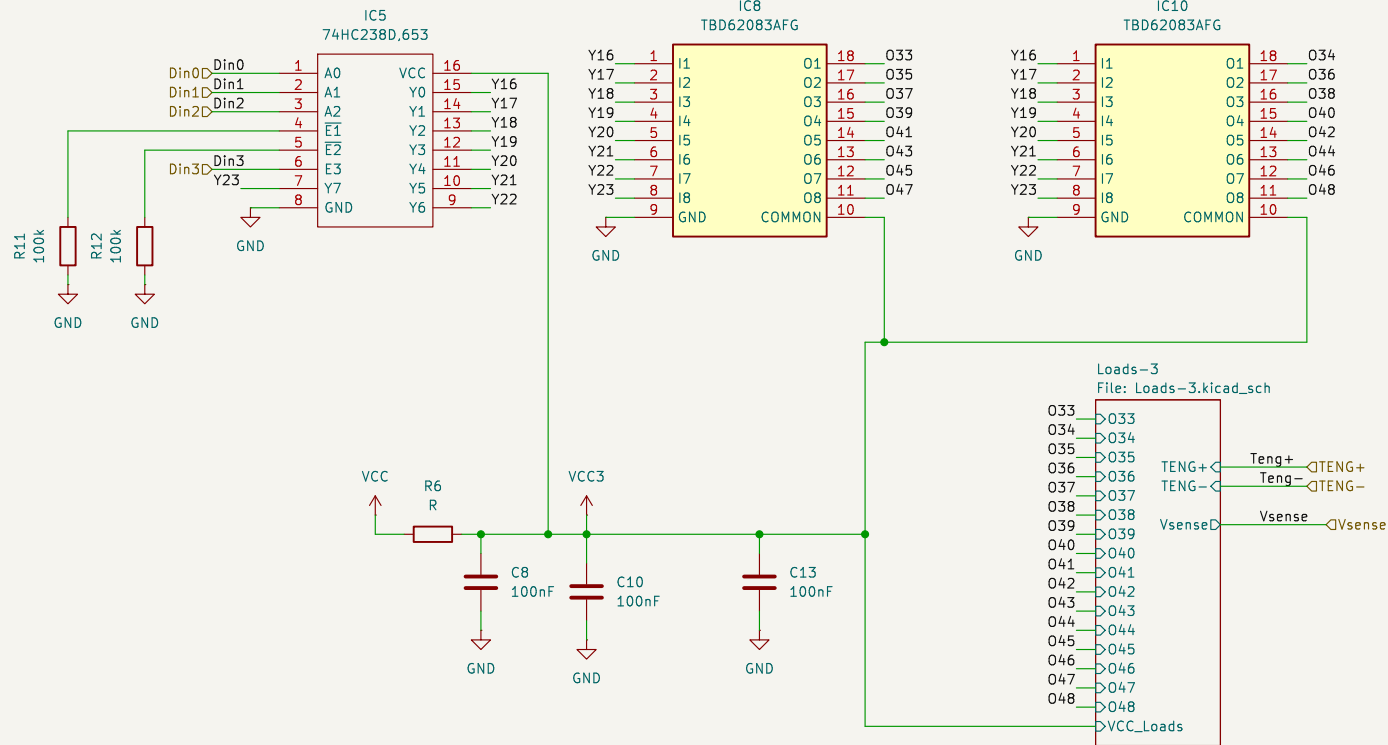

Sheet: /3\_Loads/  
 File: 3\_Loads.kicad\_sch

**Title:**

Size: A4  
 KiCad E.D.A. 9.0.0

Date:

Rev:  
 Id: 6/7

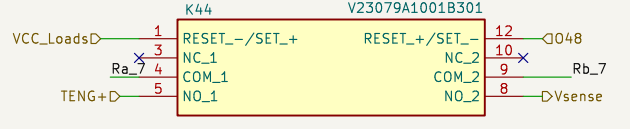
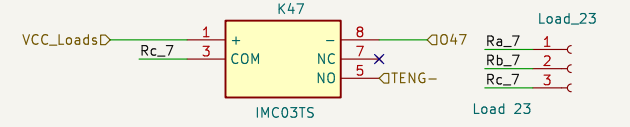
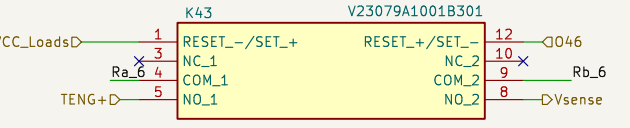
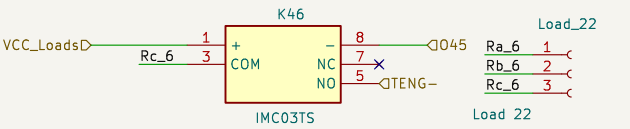
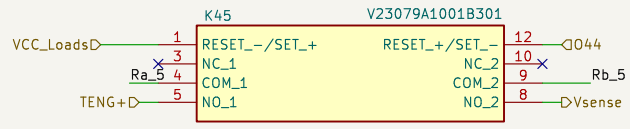
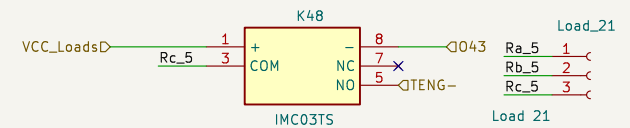
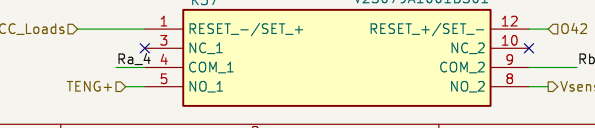
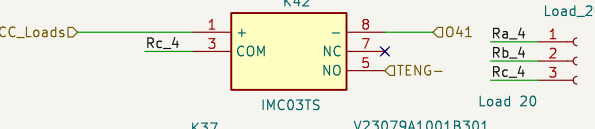
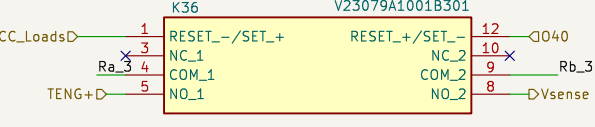
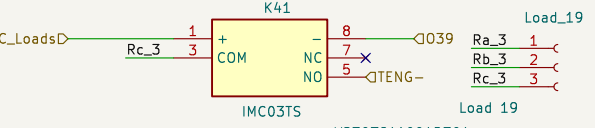
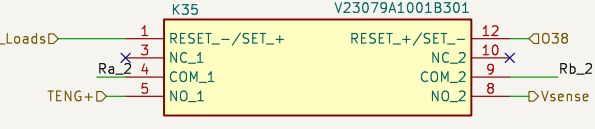
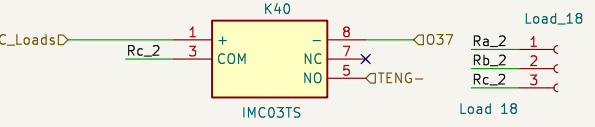
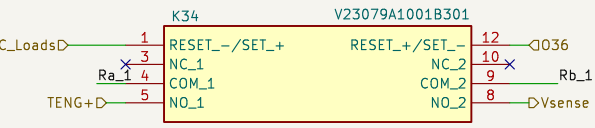
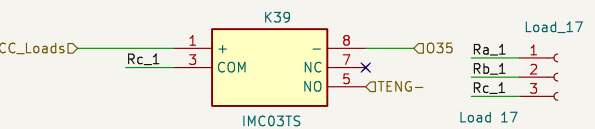
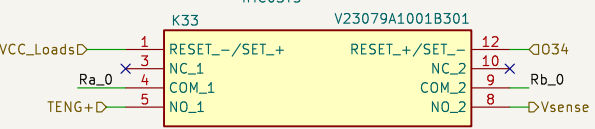
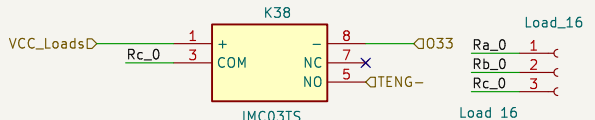

Sheet: /3_Loads/Loads-3/		File: Loads-3.kicad_sch	
<b>Title:</b>			
Size: A4	Date:	Rev:	
KiCad E.D.A. 9.0.0		Id: 7/7	