

-  H1 MountingHole
-  H2 MountingHole
-  H3 MountingHole
-  H4 MountingHole

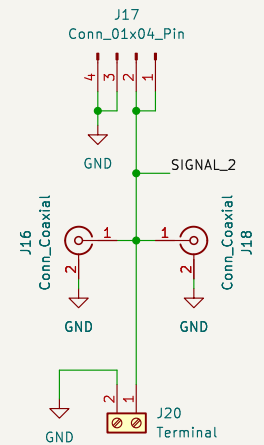
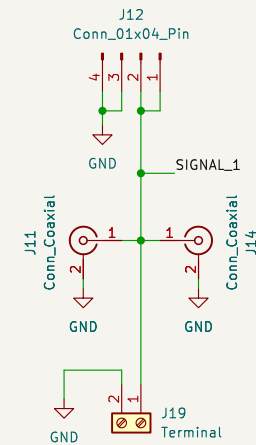
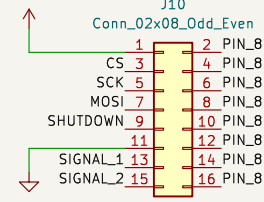
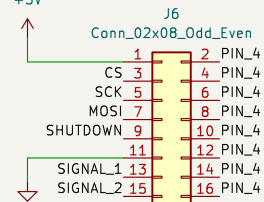
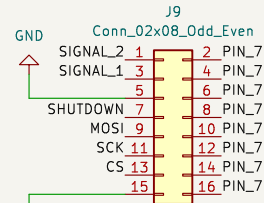
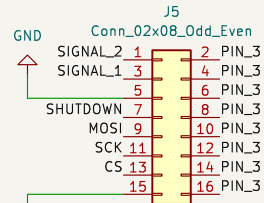
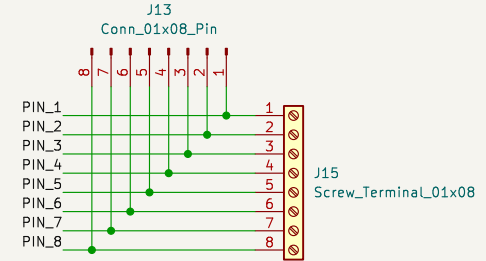
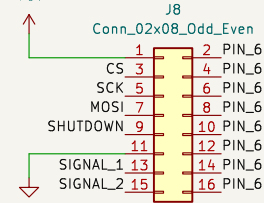
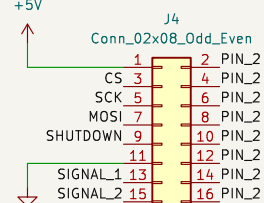
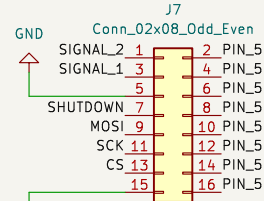
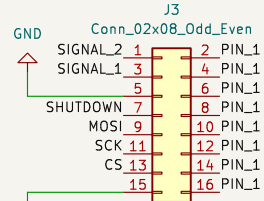
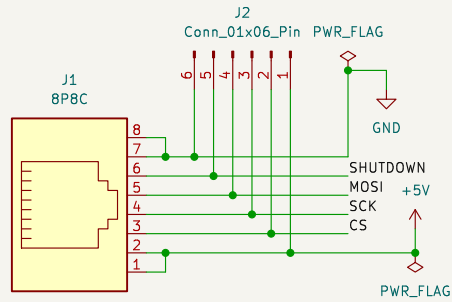

Sheet: /
File: CabelAdapter.kicad_sch

Title:

Size: A4
KiCad E.D.A. 9.0.0

Date:

Rev:

Id: 1/1