





-  H1 MountingHole
-  H2 MountingHole
-  H3 MountingHole
-  H4 MountingHole



Sheet: /	
File: phased_array_ultrasonic_row.kicad_sch	
Title:	
Size: A4	Date:
KiCad E.D.A. 9.0.0	Rev: Id: 1/4

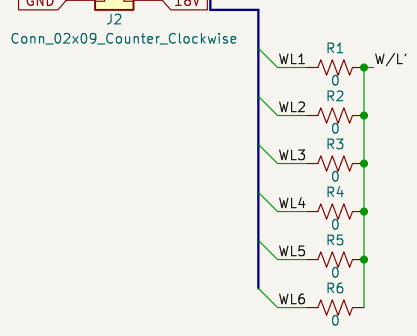
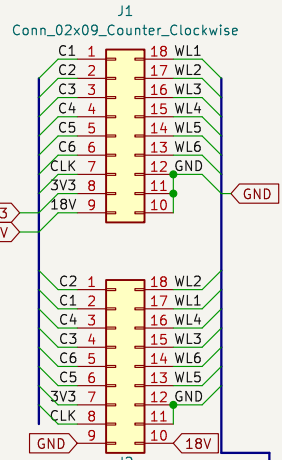
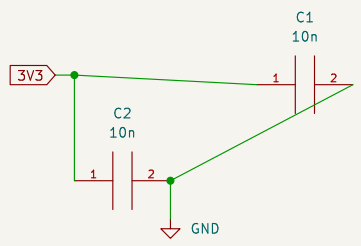
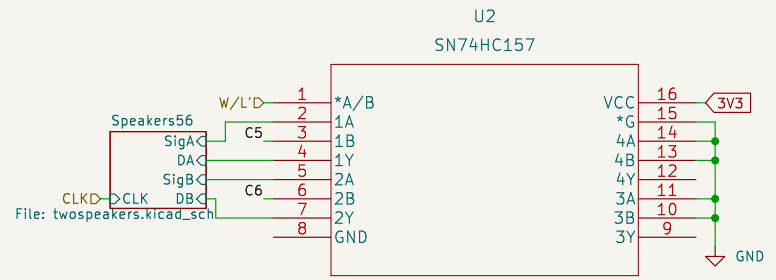
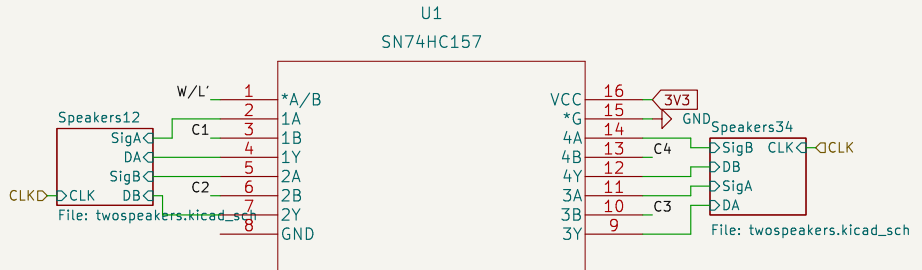
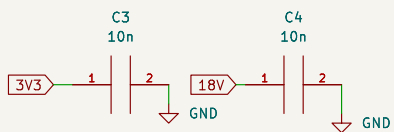
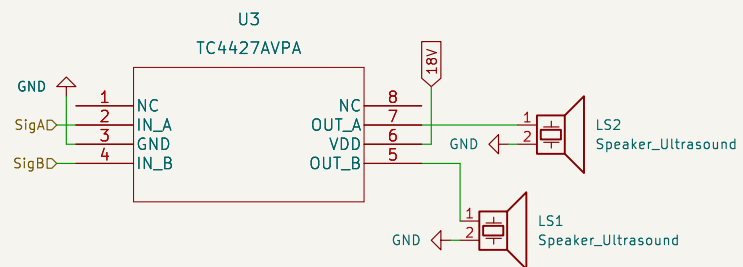

Sheet: /Speakers12/
File: twospeakers.kicad_sch

Title:

Size: A4
KiCad E.D.A. 9.0.0

Date:

Rev:
Id: 17/4

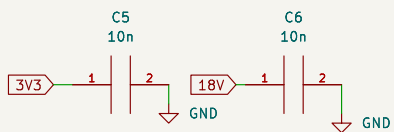
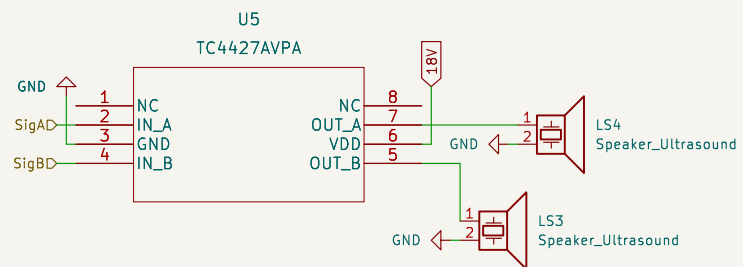

Sheet: /Speakers34/
 File: twospeakers.kicad_sch

Title:

Size: A4
 KiCad E.D.A. 9.0.0

Date:

Rev:
 Id: 21/4

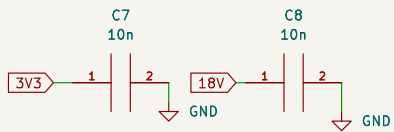
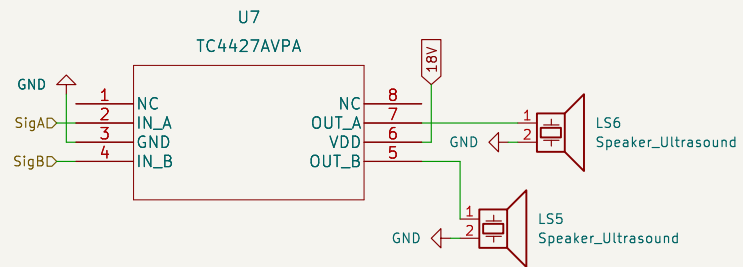
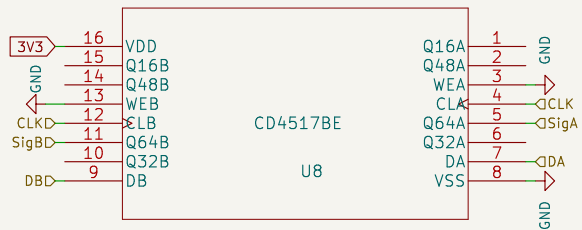

Sheet: /Speakers56/
File: twospeakers.kicad_sch

Title:

Size: A4
KiCad E.D.A. 9.0.0

Date:

Rev:
Id: 25/4