

Power In

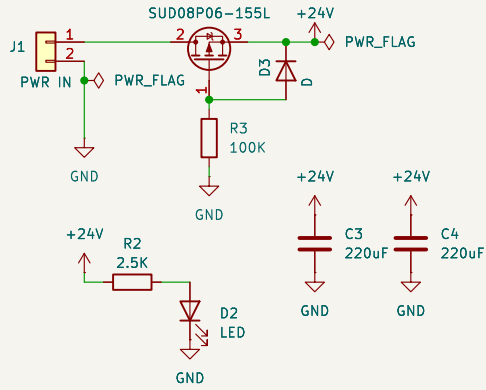

Motor Out 0

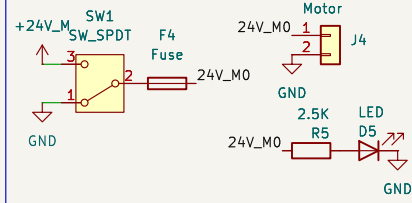

Motor Out 1

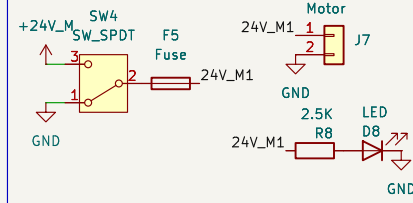

Motor Out 2

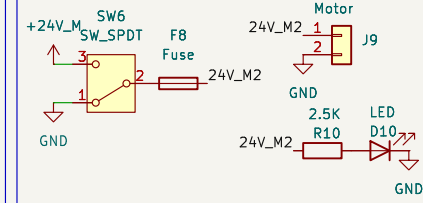

Motor Out 3

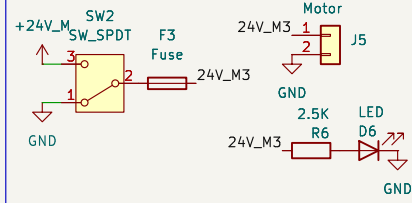

Motor Out 4

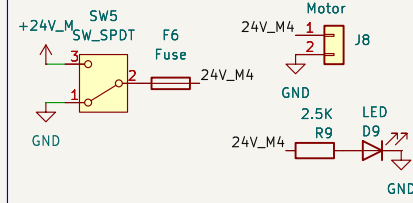

Motor Out 5

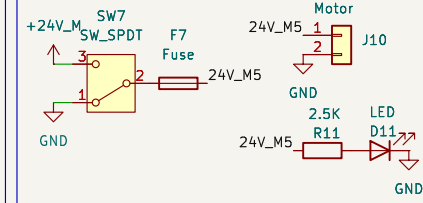

Mainboard Out

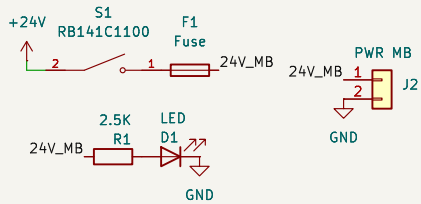

Motor Out 6

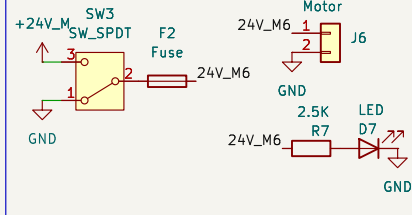

Holes

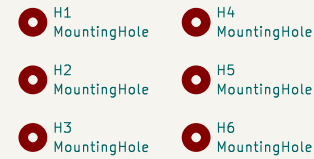

Relay

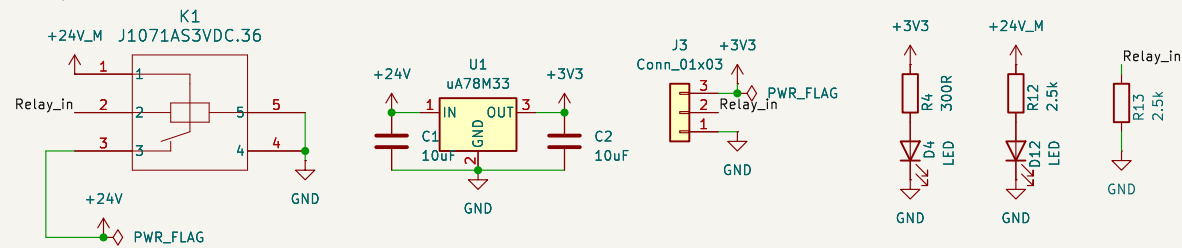

Sheet: /
File: Power_PCB.kicad_sch

Title:

Size: A4
KiCad E.D.A. 9.0.0

Date:

Rev:

Id: 1/1