

# 12-12 NI Arena

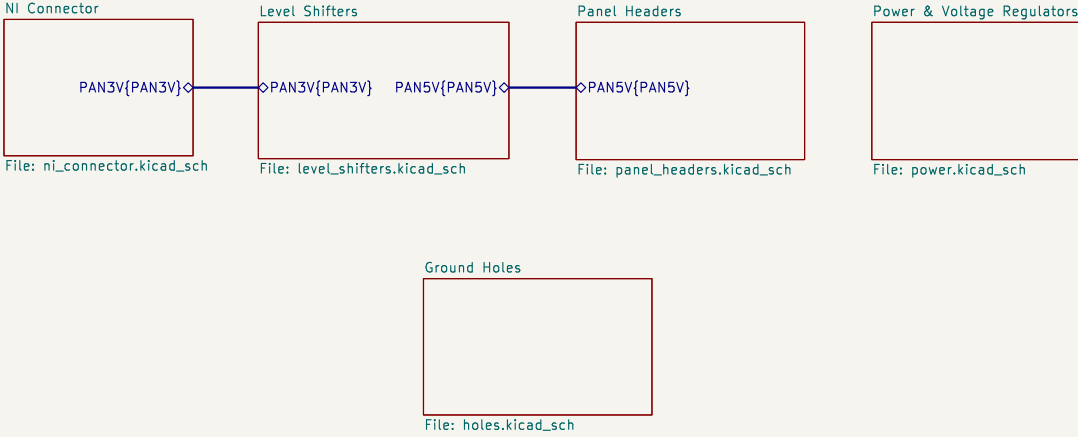

<b>IORodeo for Reiserlab ● Janelia</b>			
Sheet: /			
File: arena_12-12_v8_ni.kicad_sch			
<b>Title: 12-12 NI G4.1 Arena Modular LED Display</b>			
Size: User	Date: 2025-08-06	Rev: v8.4	
KiCad E.D.A. 9.0.0		Id: 1/6	

# Panel Headers

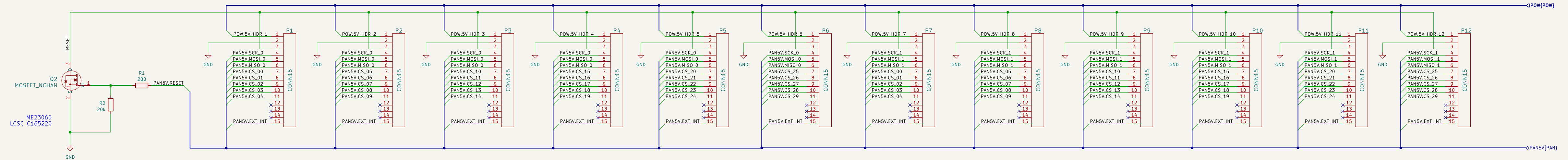

# Level Shifters

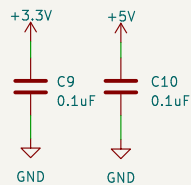
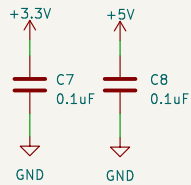
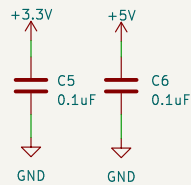
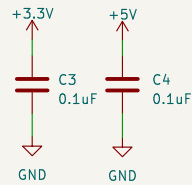
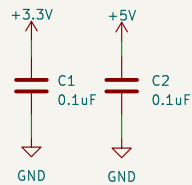
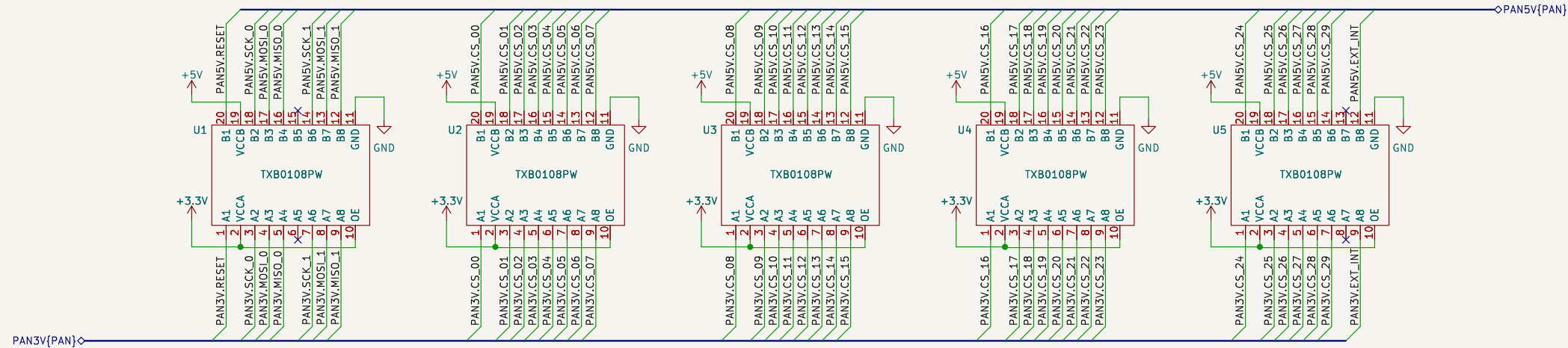

<b>IORodeo for Reiserlab @ Janelia</b>		
Sheet: /Level Shifters/ File: level_shifters.kicad_sch		
<b>Title: 12-12 Teensy G4.1 Arena Modular LED Display</b>		
Size: User	Date: 2024-12-23	Rev: v9.2
KiCad E.D.A. 9.0.0		Id: 3/6

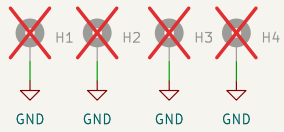

**IORodeo for Reiserlab**  **Janelia**

Sheet: /Ground Holes/  
File: holes.kicad\_sch

**Title: 12-12 Teensy G4.1 Arena Modular LED Display**

Size: USLetter Date: 2024-12-23  
KiCad E.D.A. 9.0.0

**Rev: v9.2**  
Id: 6/6

## Power & Voltage Regulation

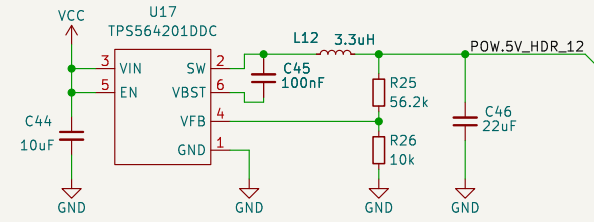
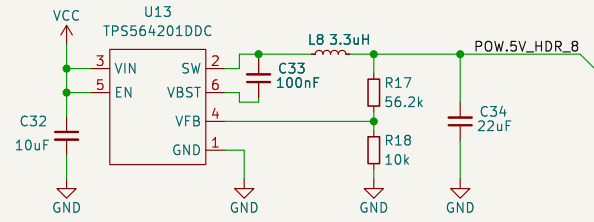
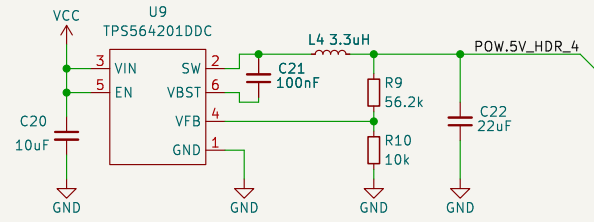
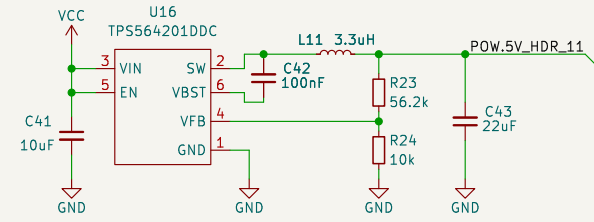
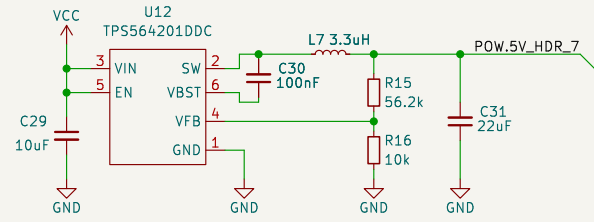
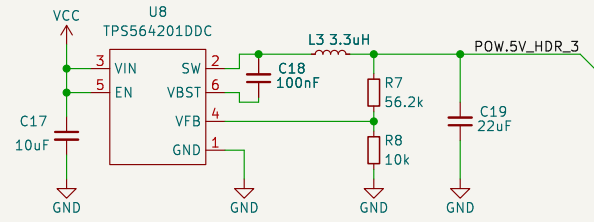
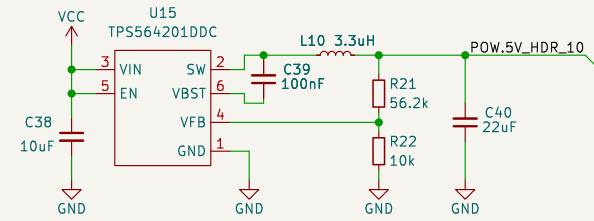
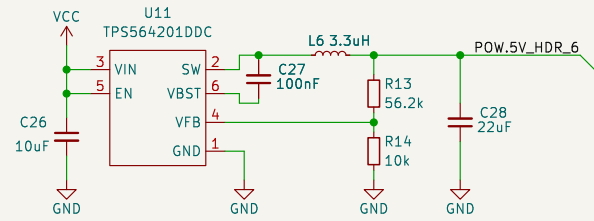
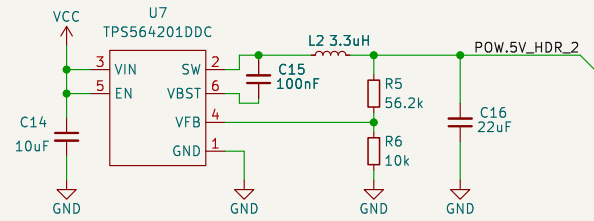
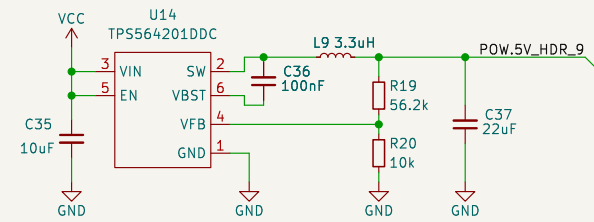
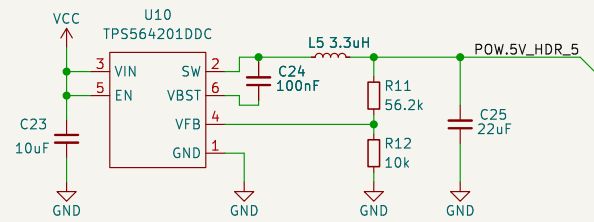
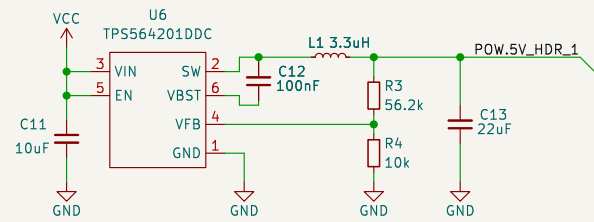

▷POW{POW}

8.5A 3.3uH ±20% 19.9mΩ SMD,7.2x6.6mm Inductors, LCSC PN C5189753

Step-Down Voltage Regulator,  
6.5A LCSC PN C5189747  
8.0A LCSC PN C464812

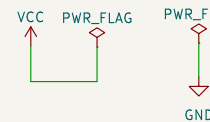
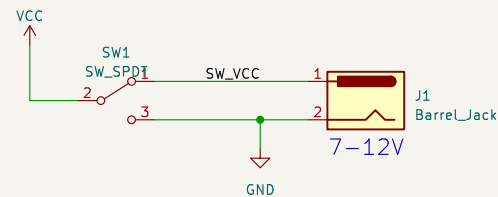

**IORodeo for Reiserlab • Janelia**

Sheet: /Power & Voltage Regulators/  
File: power.kicad\_sch

**Title: 12-12 Teensy G4.1 Arena Modular LED Display**

Size: User Date: 2024-12-23

Rev: v9.2

KiCad E.D.A. 9.0.0

Id: 6/6

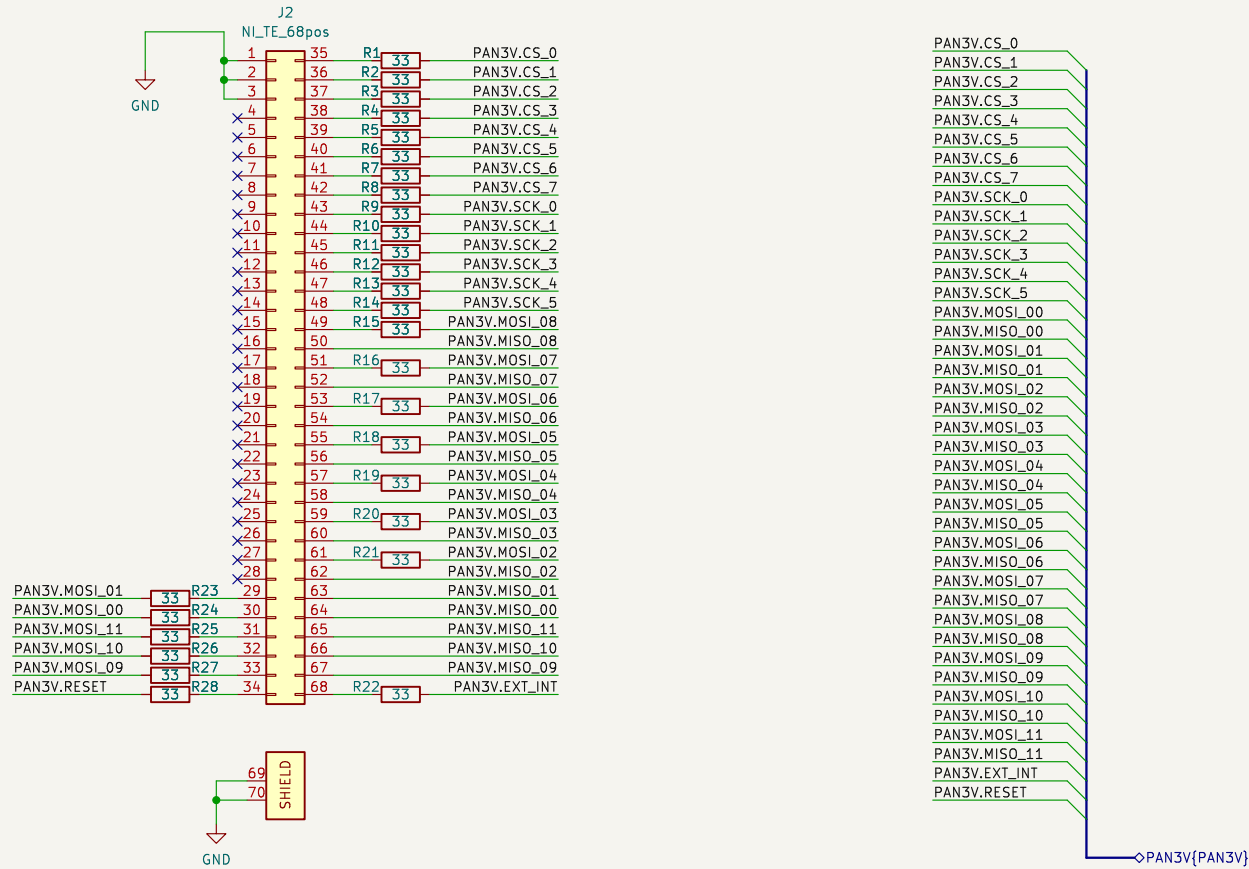

68-pin DSUB for NI cable, vertical  
 TE Connectivity 5174339-5  
 Digikey PN A123166-ND

**IORodeo for Reiserlab** ● Janelia

Sheet: /NI Connector/  
 File: ni\_connector.kicad\_sch

**Title: 12-12 NI G4.1 Arena Modular LED Display**

Size: A4 Date: 2025-08-06

Rev: v8.4

KiCad E.D.A. 9.0.0

Id: 7/6