

# NOTES: (UNLESS OTHERWISE SPECIFIED)

1) xxxx

WHILE PWR\_OK = HIGH &  
SIMPWR\_MASTERON = HIGH:  
PS\_ON = HIGH  
ELSE  
PS\_ON = LOW

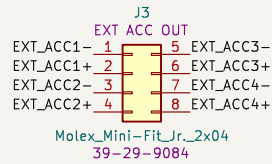
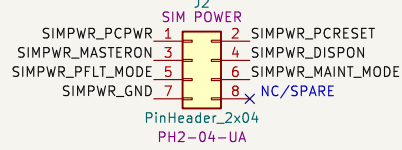
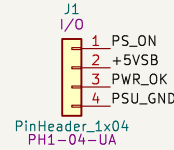
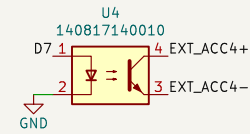
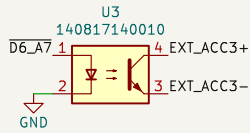
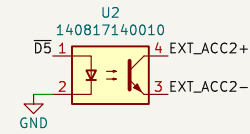
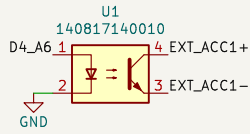

NOTE: IN ARDUINO CODE:  
USE "SERIAL" FOR USB;  
"SERIAL1" FOR TX/RX PINS.

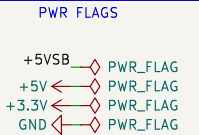
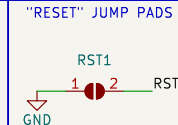
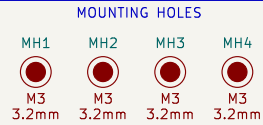
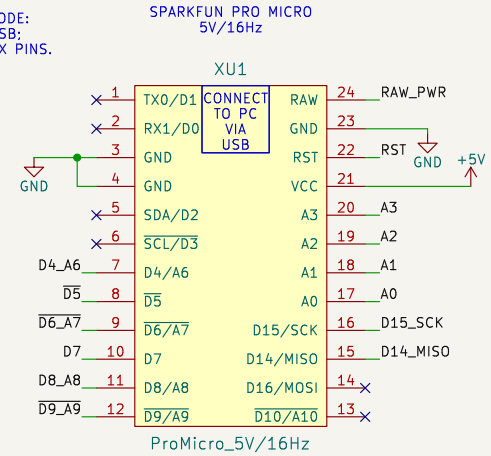

LOGOS/SILKSCREENS



LINKED NETS

NOTE: NO EFFECT ON PCB. THIS IS USED TO SHOW WHICH NETS ARE LINKED TO EACH OTHER. FOR EXAMPLE THE "PC POWER" PIN ON J2 (SIM POWER CONNECTION) CONNECTS TO A3.

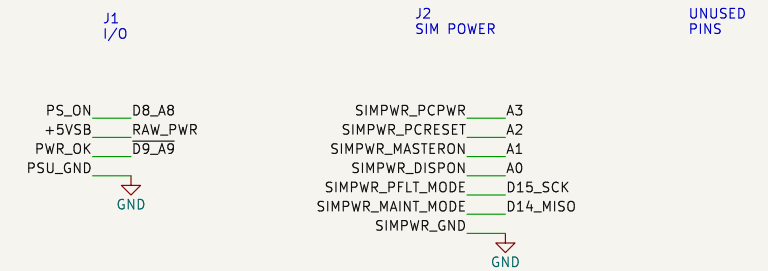

License: CC BY-NC-SA

[www.openhornet.com](http://www.openhornet.com)

Sheet: /

File: ABSIS\_Pit Management System.kicad\_sch

**Title: ABSIS Pit Management System**

Size: A Date: 2023-05-17

KiCad E.D.A. 9.0.0

Rev: 1

Id: 1/1