

Left

Right

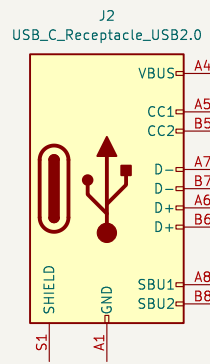

Physical reset switch

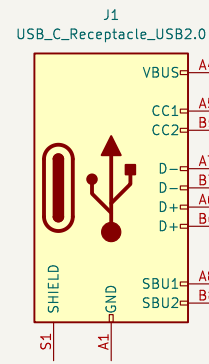

Physical reset switch

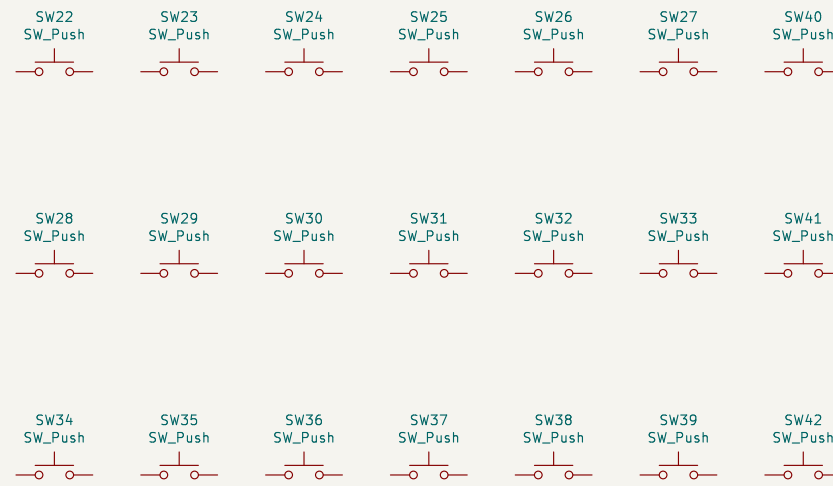
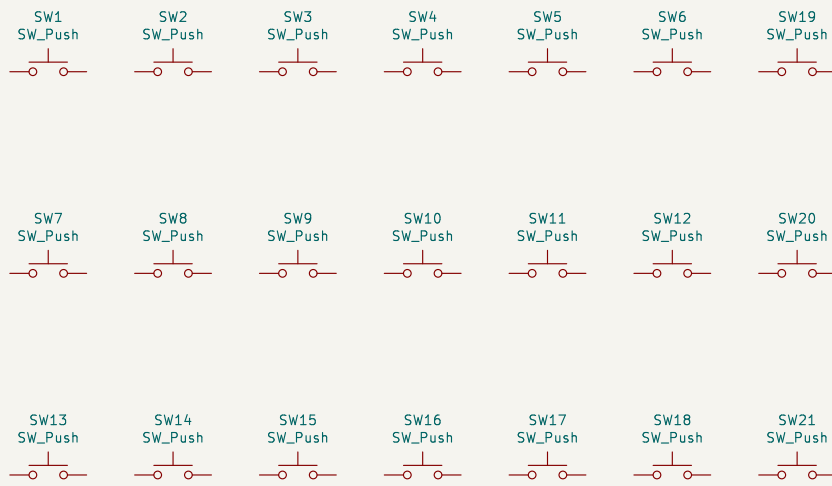

TRRS or USB-C split comms

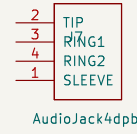

Rotary encoders

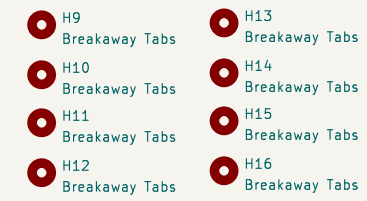
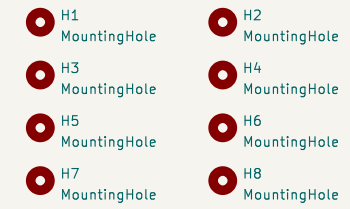
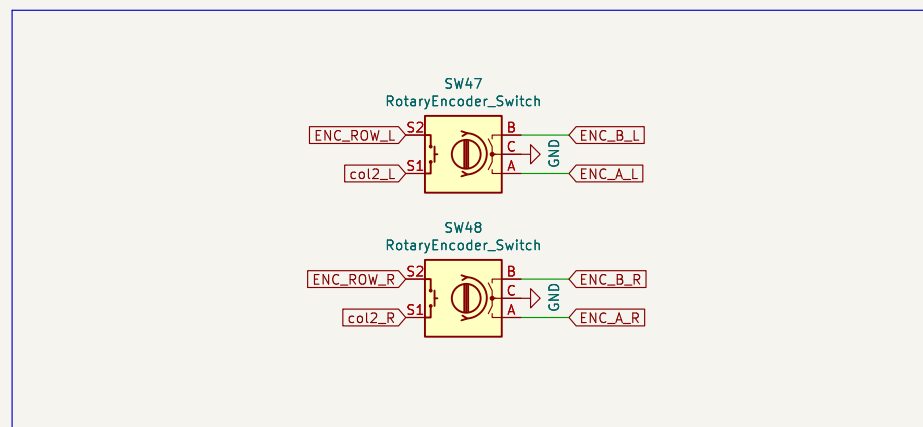

Sheet: /
 File: ximi-plates-template.kicad_sch

Title:

Size: User Date:
 KiCad E.D.A. 9.0.0

Rev:
 Id: 1/1