

White - HTB  
Blue - 5V EN  
Red - 12V EN

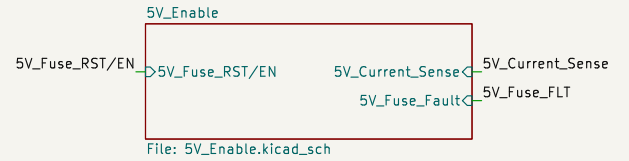

File: 5V\_Enable.kicad\_sch

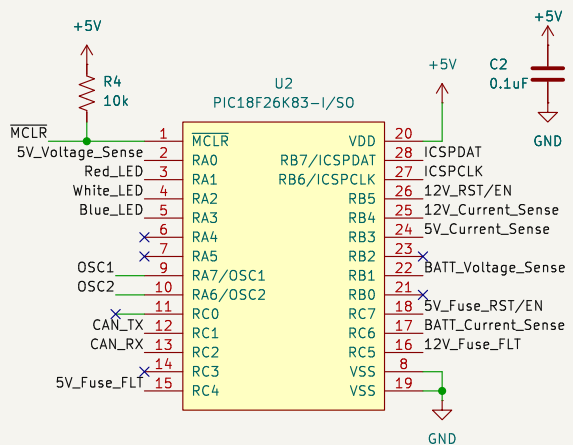
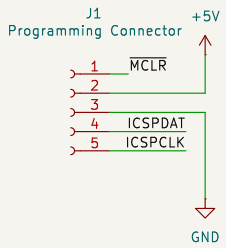
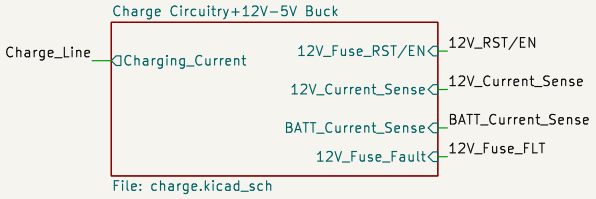

File: charge.kicad\_sch

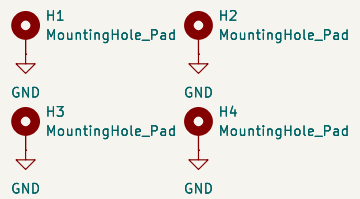
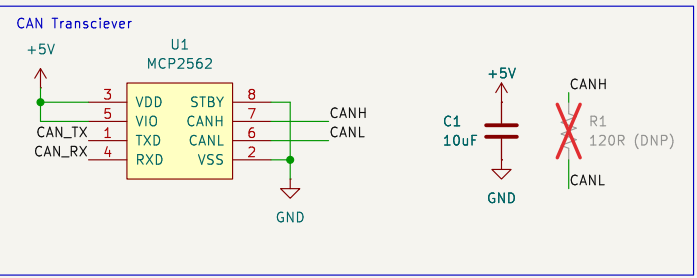
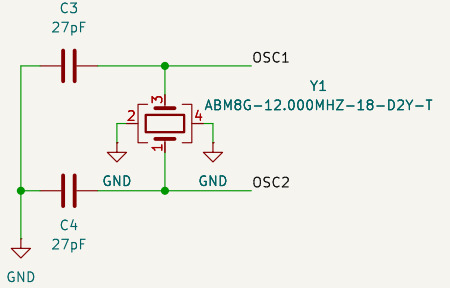

Board Calculations:  
<https://docs.google.com/spreadsheets/d/1UJF21cwi6ssP3hu2kBr7bqXh9viKXAQv16xxoFh8vw/edit?usp=sharing>

Pranav Mahabal	
Waterloo Rocketry	
Sheet: /	
File: rocket_power_board.kicad_sch	
<b>Title: Rocket Power Board</b>	
Size: A4	Date: 2024-11-25
KiCad E.D.A. 9.0.0	Rev: 1
	Id: 1/3

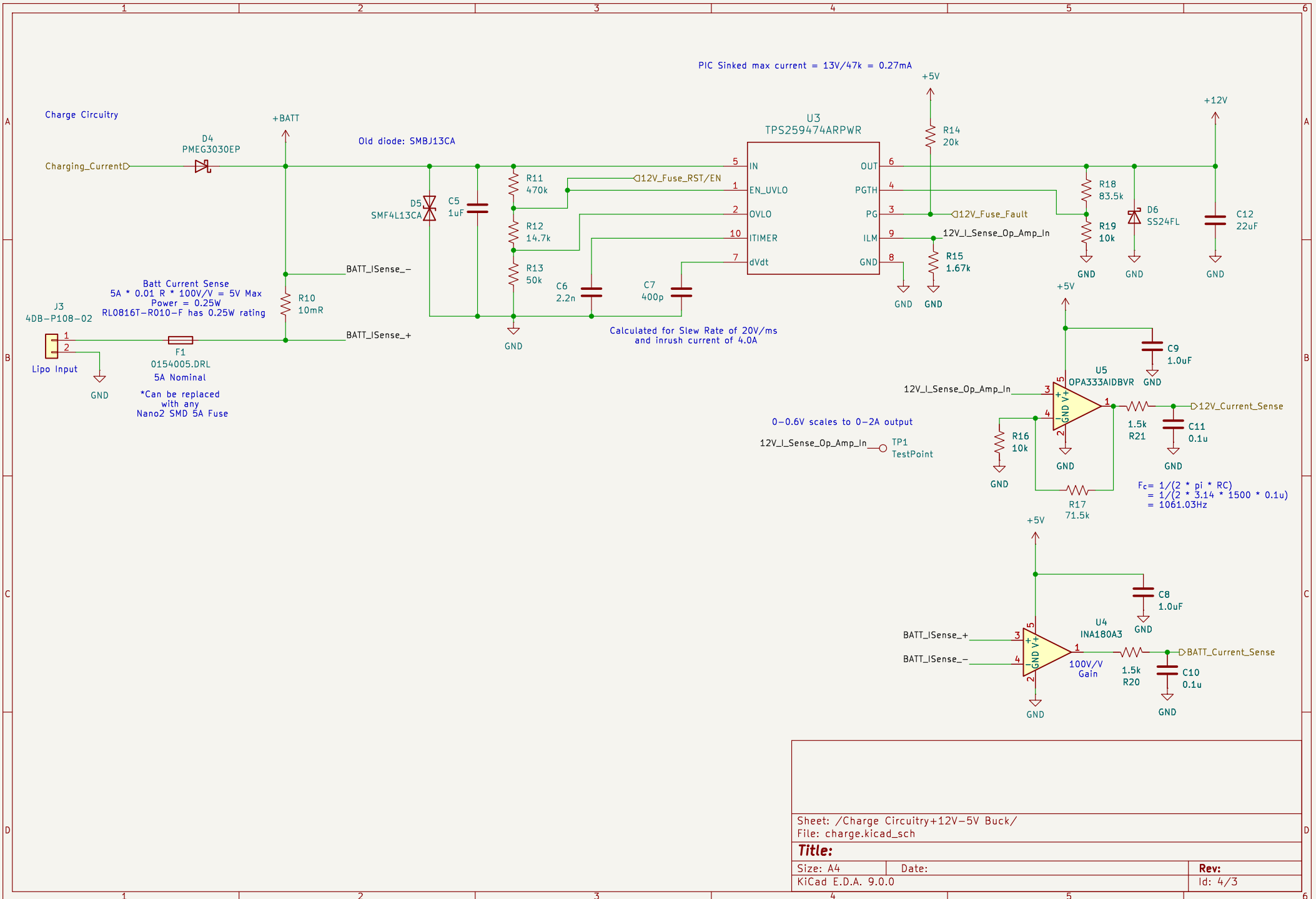

Sheet: /Charge Circuitry+12V-5V Buck/  
 File: charge.kicad\_sch

<b>Title:</b>	
Size: A4	Date:
KiCad E.D.A. 9.0.0	
Rev:	Id: 4/3

